

# CPX 0 Windlass

## Product manual

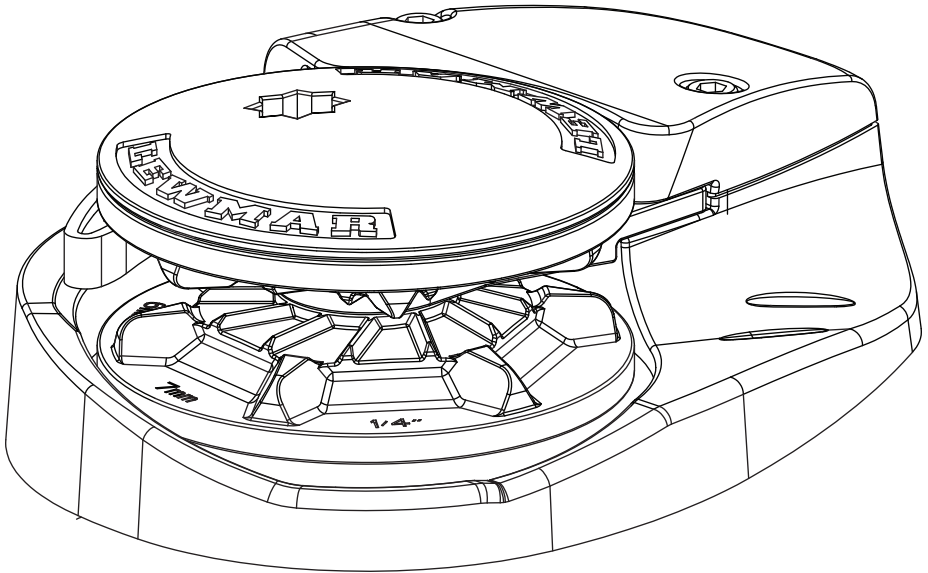

Owners Installations, Operation & servicing manual

## 1- Introduction

Thank you for choosing Lewmar. Lewmar products are world renowned for their quality, technical innovation and proven performance. With a Lewmar product you will be provided with many years of outstanding service.

Product support: Lewmar products are supported by a worldwide network of distributors and Authorised Service Representatives. If you encounter any difficulties with this product, please contact your national distributor, or your local Lewmar dealer. Details are available at: [www.lewmar.com](http://www.lewmar.com)

Certificate of Conformity available upon request

Important information about this manual:

Throughout this manual, you will see safety and product damage warnings.

You must follow these warnings carefully to avoid possible injury or damage.

## 2- Specifications

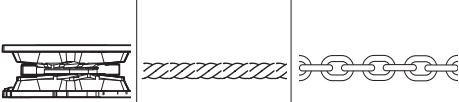
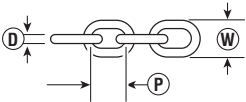
			D (mm)	D (inch)	P (mm)	P (inch)	W (mm)	W (inch)
<b>68001126</b> <b>6mm - 7mm - ¼"</b> <b>Gypsy kit</b>	12 mm (½") 3 Strand and 8 Plait	6mm DIN 766	6	0.236	18.5	0.728	20.4	0.803
		6 mm ISO 4565	6	0.236	18	0.709	21.6	0.850
		7 mm DIN 766	7	0.276	22	0.866	23.8	0.937
		¼" ACCO ISO G43 (G4)	7	0.276	21.3	0.840	24.4	0.962
		¼" ACCO BBB (3B)	7.14	0.281	22.1	0.870	25.2	0.992
<b>68001123</b> <b>8mm - 5/16"</b> <b>Gypsy kit</b>	12-16 mm (½"-5/8") 3 Strand and 8 Plait (5/8" only)	8 mm DIN 766	8	0.315	24	0.945	27.2	1.071
		8 mm ISO 4565	8	0.315	24	0.945	28.8	1.134
		5/16" ACCO ISO G43 (G4)	8.36	0.329	26.16	1.030	29.67	1.168

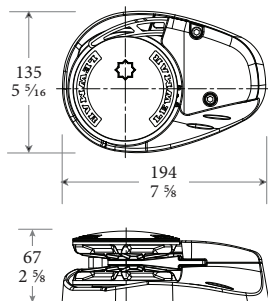

500 W Motor

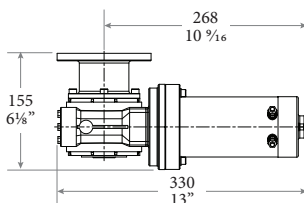

700 W Motor

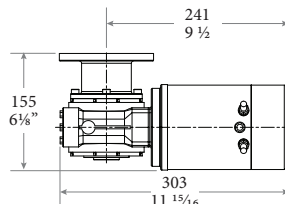

### Product specifications

MODEL	MOTOR SUPPLY	MOTOR POWER	MAXIMUM PULL		MAXIMUM LINE SPEED		WORKING LOAD LIMIT		NORMAL CURRENT DRAW	CIRCUIT BREAKER	WEIGHT	
			kg	lb	m/min.	ft/min.	kg	lb			Amp	Amp
<b>CPX0- 500W</b>	12 V	500 W	410	900	14	46	103	226	75	70	9.2	20.2
<b>CPX0- 700W</b>	12 V	700 W	600	1320	15.5	51	150	330	105	90	17	37.4

## 3- Safety Notice



**IMPORTANT:** Read these notes before continuing.

### 3.1 Windlass general

At all times it is the responsibility of the boat user to ensure that the anchor and rode are properly stowed for the prevailing sea conditions. This is particularly important with high-speed powerboats, because an anchor accidentally deploying while under way can cause considerable damage. An anchor windlass is mounted in the most exposed position on a vessel and is thus subject to severe atmospheric attack resulting in a possibility of corrosion in excess of that experienced with most other items of deck equipment. As the windlass may only be used infrequently, the risk of corrosion is further increased. It is essential that the windlass is regularly examined, operated and given any necessary maintenance.

Please ensure that you thoroughly understand the operation and safety requirements of the windlass before commencing the installation. Only persons who are completely familiar with the controls and those who have been fully made aware of the correct use of the windlass should be allowed to use it. If there is any doubt of how to install or operate this unit please seek advice from a suitably qualified engineer.

- Windlasses used incorrectly could cause harm to equipment or crew.
- Windlasses should be used with care and treated with respect.
- Boating, like many other activities can be hazardous. Even the correct selection, maintenance and use of proper equipment cannot eliminate the potential for danger, serious injury or death.
- Lewmar windlasses are designed and supplied for anchor control in marine applications and are not to be used in conjunction with any other use.
- Keep limbs, fingers, clothing and hair clear of windlass and anchor rope/chain and anchor during operation. Severe bodily harm would result.
- Ensure there are no swimmers or divers nearby when dropping anchor.
- When the Windlass is not in use the anchor must be tied off onto a cleat or equivalent strong point to prevent damage to the boat.
- Windlass must not be used as the sole means of securing the anchor to the bow fitting especially under storm conditions. Anchors should be independently secured to prevent accidental release.
- Classification Societies require that a vessel lying at anchor must have its anchor rope/chain secured to a chain stopper or other suitable independent strong point.

A windlass should never be used as a mooring bollard, the anchor rode **MUST** be secured to a mooring cleat, chain stopper or other designated strong point. Using the windlass to secure the rode will damage the windlass.

- Do not use windlass for ANY purpose other than deployment and recovery of anchor.
- Do not wrap chain around a capstan barrel or drum where fitted.
- A circuit breaker/isolator should always be used with this windlass to protect the motor and cables from overheating and damage.
- Always switch off this windlass at the circuit breaker/isolator when not in use.
- It is the unavoidable responsibility of the owner or master or other responsible party to assess the risk of any operation on the vessel.
- Windlass must not be operated whilst under the influence of alcohol or drugs.

### 3.2 Fitting

- This equipment must be installed and operated in accordance with the instructions contained in this manual. Failure to do so could result in poor product performance, personal injury and/or damage to your boat.
- Consult the boat manufacturer if you have any doubt about the strength or suitability of the mounting location.

### 3.3 Electrical

- Make sure you have switched off the power before you start installing this product.
- This product requires installation by a suitably qualified electrical engineer.

## 4- Installation

### 4.1 Basic requirements

Each installation requires the following tools:

#### Windlass Installation

- An appropriate marine sealant
- Electric drill and 10mm (3/8"), 14mm (9/16") and 18mm (3/4") drill bit
- Ø40 mm (1 9/16") and 65mm (2 1/2") Hole Saw

#### Wiring Installation

- Crimping Pliers / Wire Stripper
- Suitable electrical cable and crimp terminals

### 4.2 Accessories

Use only genuine Lewmar parts and accessories to ensure top performance and eliminate the risk of

voiding your warranty. For replacement parts, please visit your dealer or [www.lewmar.com](http://www.lewmar.com)

### 4.3 Gypsy Suitability

Gypsies are ideally suited to handling our factory made Rope/Chain combination rodes, which consist of rope spliced to a chain tail. See §2 Specifications for details.

Therefore, rope and chain from other manufacturers may require some experimentation to determine the optimum size.

Ropes used must be windlass grade, medium lay nylon. Ropes from different manufacturers have wide variations in stretch and consistency in diameter.

Should you have difficulty in matching a gypsy to your chain please consult your local agent or our international network of distributors.

### 4.4 Above deck preparation

**IMPORTANT** - Plan location carefully and allow for the following:

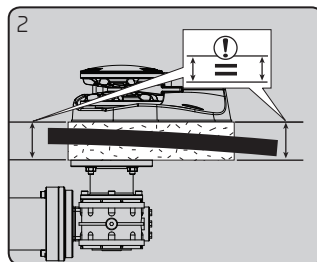
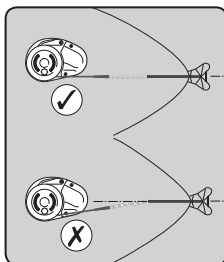
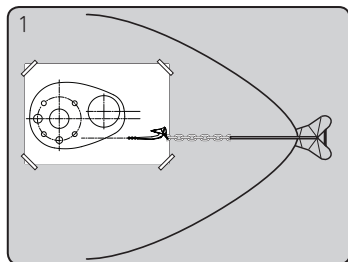

1. Use drilling template provided and choose an appropriate position with reference to the vessel's bow roller and the chain locker below. Allow for the rotation of the manual operating lever.
2. If possible select a flat area of deck. If the deck is not flat, care must be taken to ensure that the windlass base is parallel to the motor/gearbox mounting flange. Shims may be used, before the motor/gearbox is installed, to correct minor misalignment
3. Lewmar recommends a minimum deck thickness of 25mm (1"), M8 Studs suit deck and packing thickness of 25-50mm (1" - 2").

**NOTE:** If in doubt about the suitable construction of the shims consult a qualified marine engineer. The deck is an integral component of the windlass it has to secure the windlass and be strong enough to cope with the high torque stresses involved in recovering the anchor. Decks that are thin, or of foam or balsa laminate construction, will require reinforcement in order to spread the loads that will be applied to the deck while the windlass is in use.

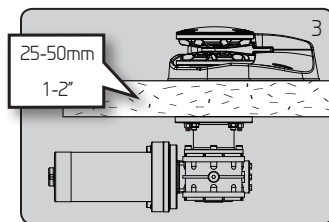

## 4.5 Below deck preparation

### IMPORTANT:

The positioning of the windlass must be checked prior to cutting for deck/hull and bulkhead clearance.

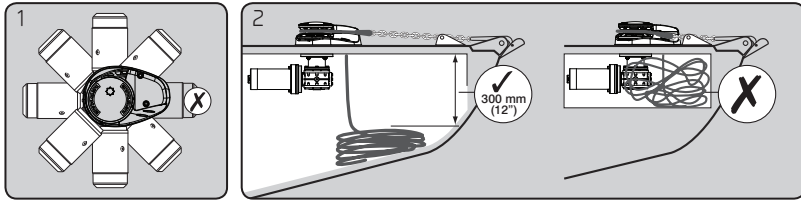

1. The motor/gearbox is bolted via the through deck mounting bolts.  
Do not position motor/gearbox below rode/chain pipe fall area.

2. There must be sufficient vertical fall for the chain or rope when hauling in.

**⚠ WARNING!** Failure to provide minimum vertical fall will cause jamming.

## 4.6 Above deck fitting

Using the template and after you have checked all the above and below deck requirements cut the following holes:

Using a 10mm ( $\frac{3}{8}$ " ) diameter drill bit, make the three holes for the mounting studs and two for the motor cables. With a 76mm (3") diameter hole saw, make one hole for the rode to pass through.

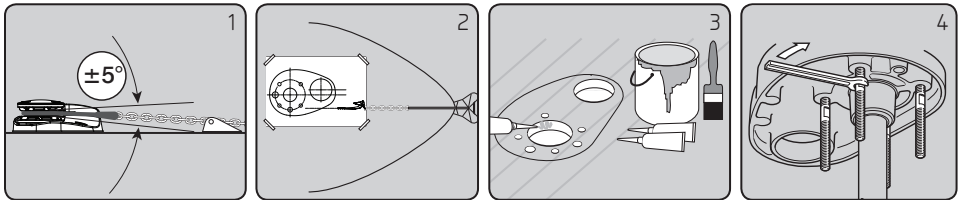

1. Lead from the roller should be fed horizontally back to the top of the gypsy and along its centre line within  $\pm 5^\circ$ .

2. Using your template and after you have checked all the above and below deck requirements cut the following holes. Using a 10mm ( $\frac{3}{8}$ " ) diameter drill, make the 4 holes for the mounting studs, 18mm ( $\frac{3}{4}$ " ) and 14mm ( $\frac{9}{16}$ " ) for the sensors. With a 65mm ( $2\frac{1}{2}$ " ) and 40mm ( $1\frac{5}{16}$ " ) diameter hole saw, make 2 holes for the mainshaft and rode to pass through.

3. When all the holes have been made, remove the template. To help avoid water absorption by the deck, apply an appropriate marine sealant to the freshly cut hole edges.

4. Assemble and tighten studs to 21 Nm into base until they bottom out in their holes. Position the flats of the studs nearest the base of the windlass.

5. Place the base mat in position on the deck. Optionally, apply a suitable sealant to the base of the windlass, any mounting pad or around the studs.  
NOTE: If using silicone or other rubbery type sealant, it is advisable to allow curing of the sealant before final tightening of the mounting nuts.

6. Lightly coat the shaft with grease and ensure the drive key is in place before assembly to motor/gearbox.

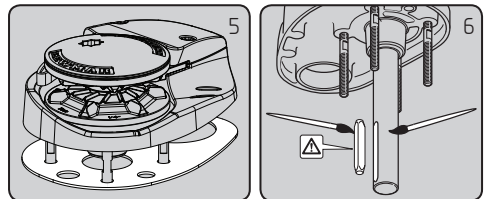

**⊘ DO NOT** use a permanent adhesive/sealant eg.5200

## 4.7 Under deck fitting

Lightly grease all moving parts.

1- Ensure drive key is in place then gently slide the motor/gearbox up the drive shaft until it contacts the deck.

NOTE: Position the motor/gearbox away from the rope/chain pipe fall.

2- Check the motor/gearbox and windlass mounting surfaces are parallel.

3- Assemble the washer then the M8 nut, secure with Loctite® threadlock to 21Nm torque.

NOTE: If using silicone or other rubbery type sealant, it is advisable to allow curing of the sealant before final tightening of the mounting nuts

⚠ DO NOT use a permanent adhesive/sealant eg.5200

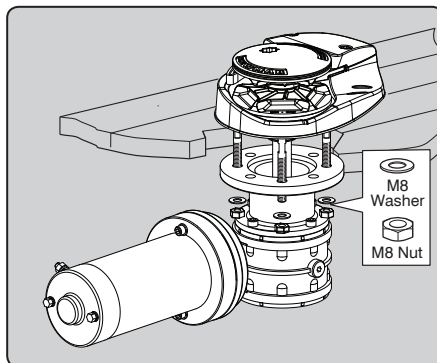

## 4.8 Loading rope/chain

For safety and performance Lewmar recommends the use of matched Lewmar anchor rodes.

⚠ WARNING! Isolate (turn off) the windlass using circuit breaker / isolator.

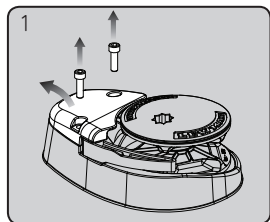

1. Remove cover.

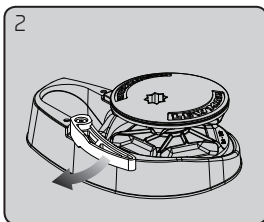

2. Pull out control arm.

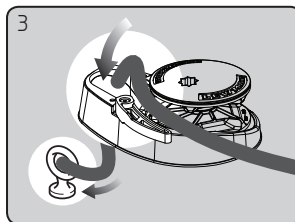

3. Feed anchor rope/chain into entry hole. Tie off to suitable strong point.

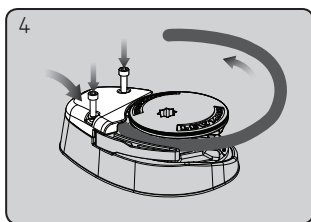

4. Replace cover. Release control arm and wrap rope/chain around gypsy.

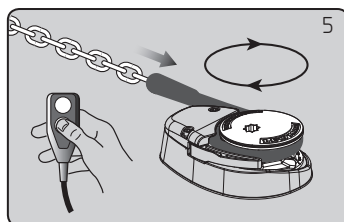

5. Power load rest of anchor rope/chain.

## 5- Electrical wiring

### 5.1 Electric cable selection

Lewmar recommends the installer source and install cable that meets the requirements of the standards and regulations relevant to the installation and codes of practice.

The cable table gives recommended cable sizes based on total length of cable required, from the battery, following the route of the cables to the windlass and back.

MODEL	CABLE SIZING FOR LENGTH OF CABLE RUN			
	up to 7 m	up to 23 ft	7 - 15 m	23 - 50 ft
500W	10 mm <sup>2</sup>	8 AWG	16 mm <sup>2</sup>	4 AWG
700W	16 mm <sup>2</sup>	6 AWG	25 mm <sup>2</sup>	4 AWG

**⚠ DO NOT confuse cable length with the length of the vessel**

Windlass performance is directly related to cable size and length. Voltage drop over the complete wiring run must not exceed 10%.

### 5.2 Wiring

Plan the installation to suit the controls and give the operator a full view of the windlass. The wiring system should be of the fully insulated type, which avoids possible electrolytic corrosion problems. We recommend the use of type III stranded, tinned copper wire with copper crimp terminals. Most modern installations are negative return (negative ground) but polarity should be checked.

Short-circuit protection, in the form of the circuit breaker provided must be built into the windlass wiring circuit.

- Circuit breaker supplied:  
CPX0-500W70A (Part No 68000240)  
CPX0-700W90A (Part No 68000349)
- The breaker must be manually reset should an overload occur that causes it to trip to the off position.
- The circuit breaker should be positioned close to the battery in a dry, readily accessible place.

**⚠ WARNING!**

If you are not sure you understand these guidelines, seek professional help. Ensure that the installation complies with USCG, ABYC, NMMA or other local regulations.

### 5.3 Control switch installation

The unit is supplied with

- Guarded rocker switch (product ref 68000593)
- Contactor (500W- 68000939 / 700W- 68000937)

Follow the wiring diagram § 5.4-5.7

NOTE: Optional electric footswitches and remote handheld control available. Visit [www.lewmar.com](http://www.lewmar.com) for more information

Contactor box used in some installation refer to wiring diagram § 5.5 and § 5.6

Optional wireless remote also available See table below for models and references

WIRELESS REMOTE (3 BUTTON WINDLASS ONLY)	WIRELESS REMOTE (5 BUTTON WINDLASS & THRUSTER)
68000967	68000968

NOTE: In a multi station installation all switches must be wired in a parallel circuit.

### 5.4 CPX0 - 500W Wiring diagram using contactor provided (Part No 68000939)

Installation instructions are supplied separately with any accessories.

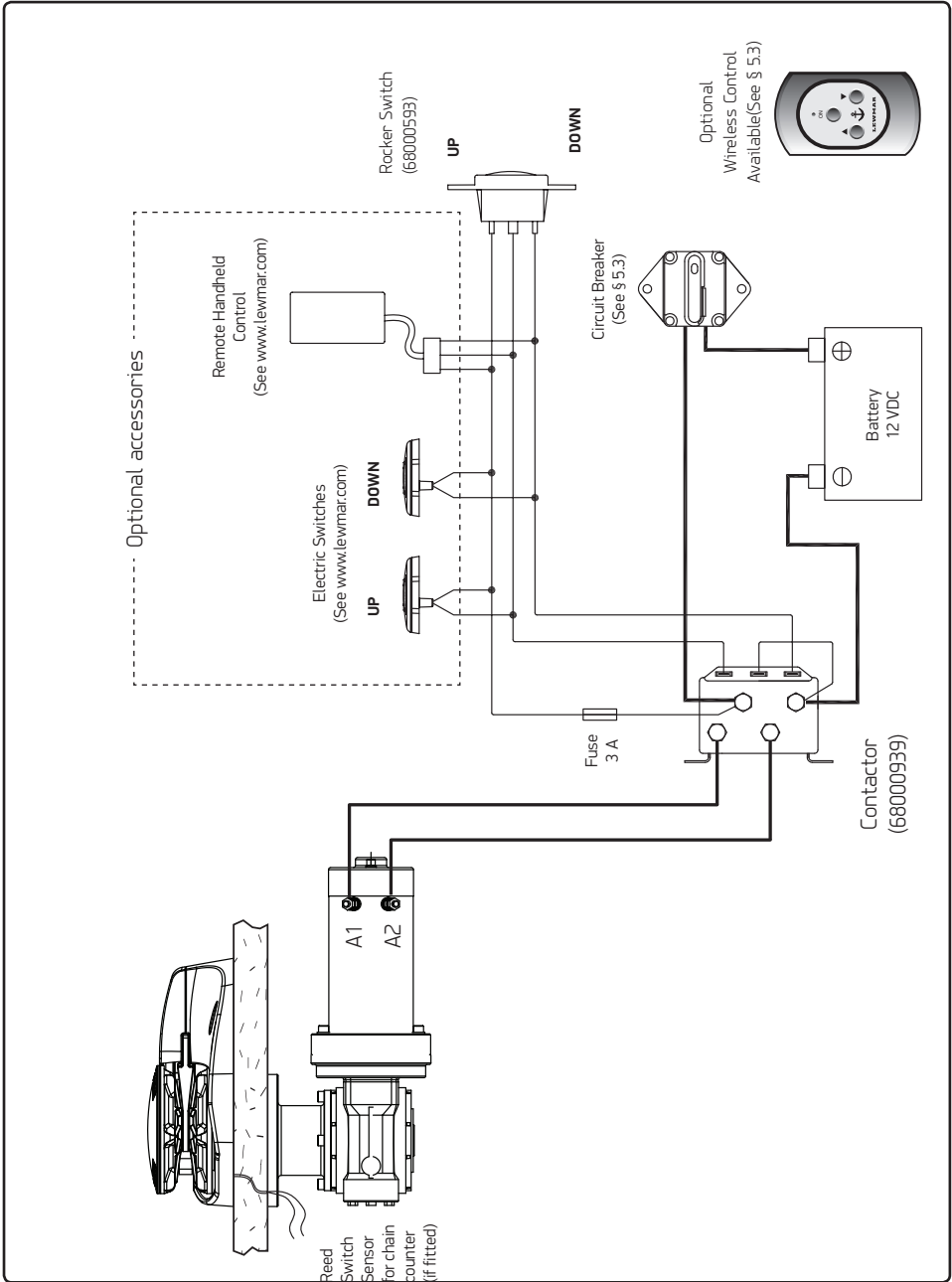



**5.5 CPX0 - 500W Wiring diagram if a contactor box (Part No 68000965) is used**

Installation instructions are supplied separately with any accessories.

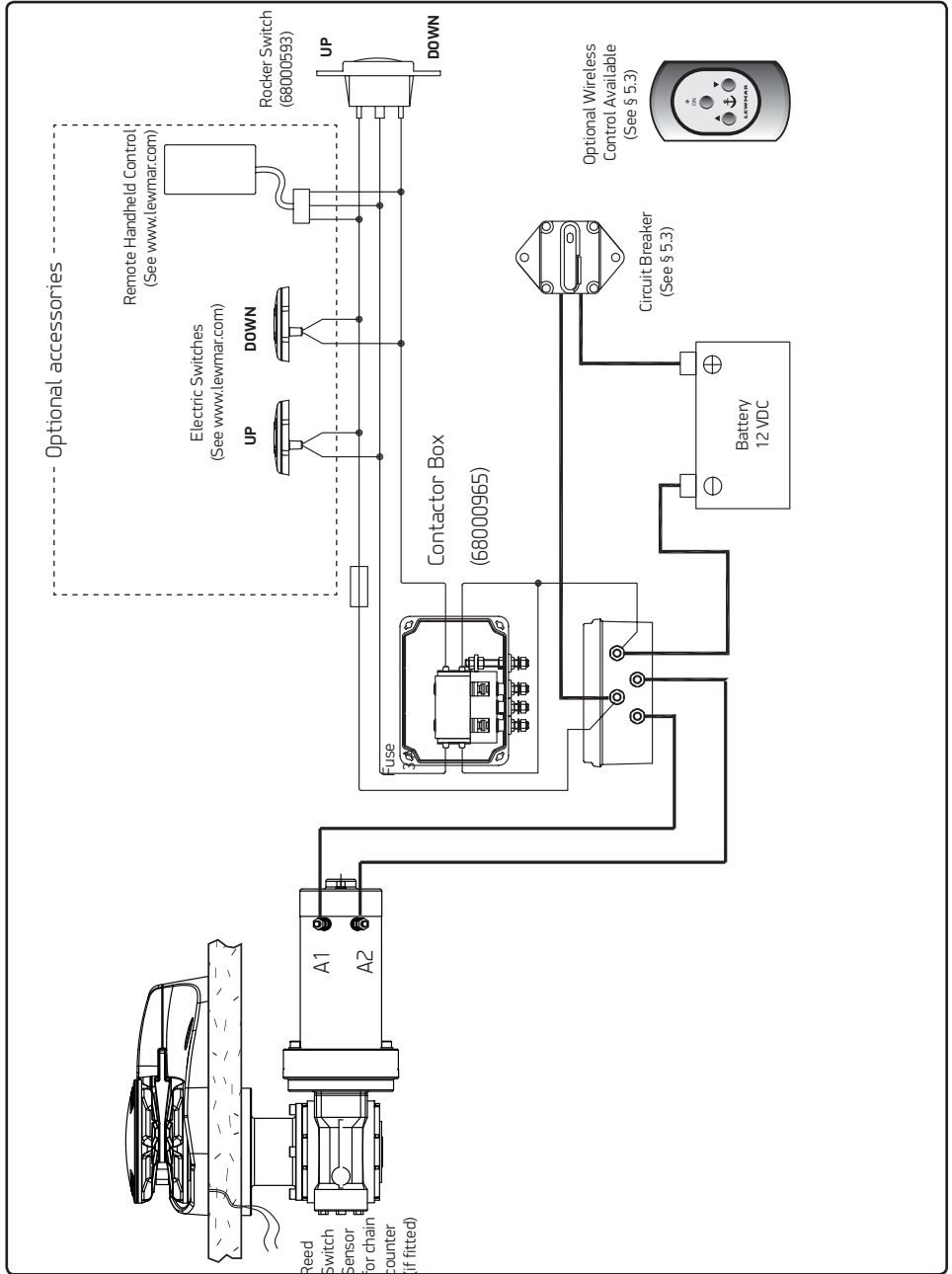

## 5.6 CPX0 - 700W Wiring diagram using contactor provided (Part No 68000937)

Installation instructions are supplied separately with any accessories.

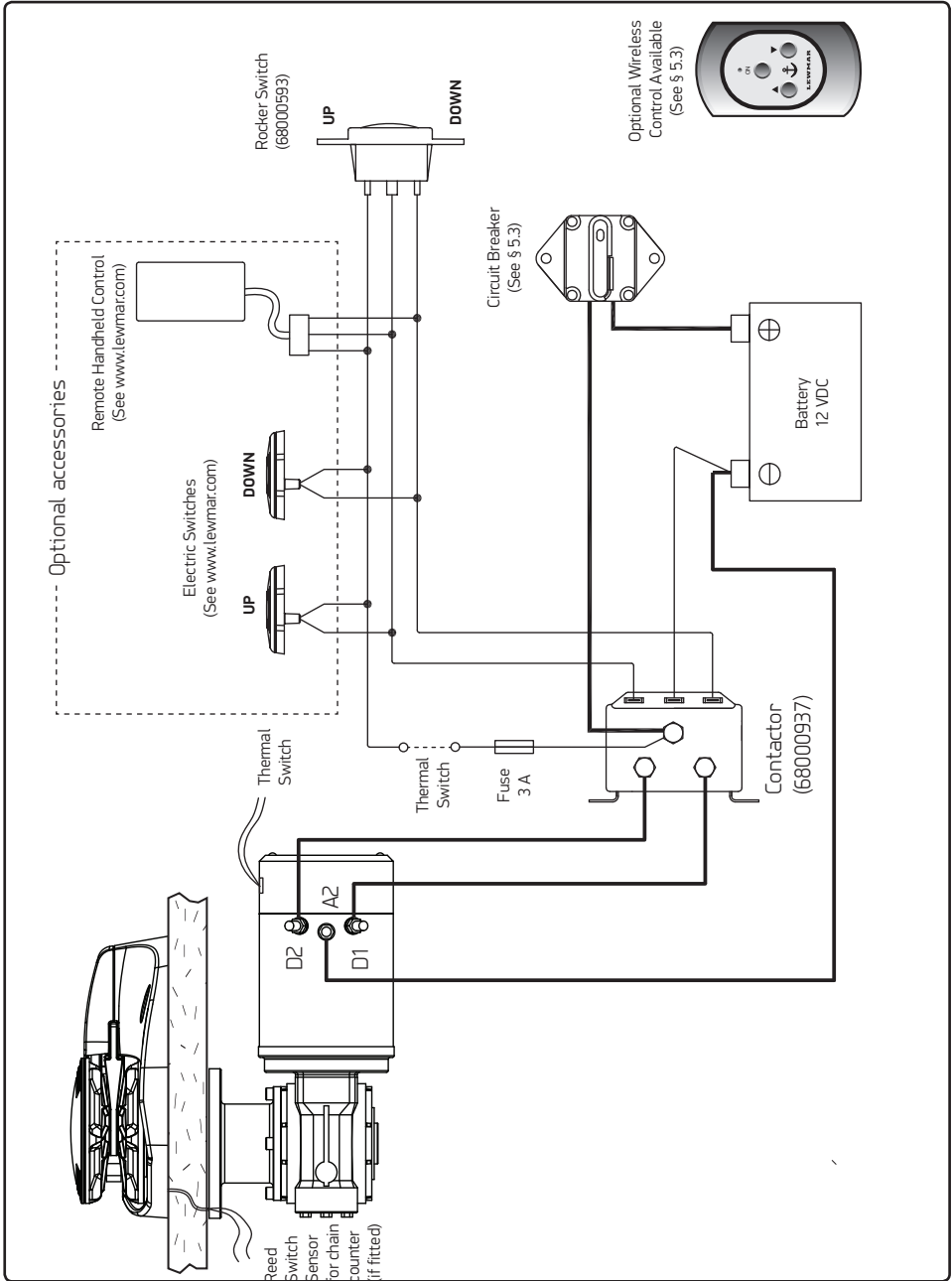

**5.7 CPX0 - 700W Wiring diagram if a contactor box (Part No 68000129) is used**

Installation instructions are supplied separately with any accessories.

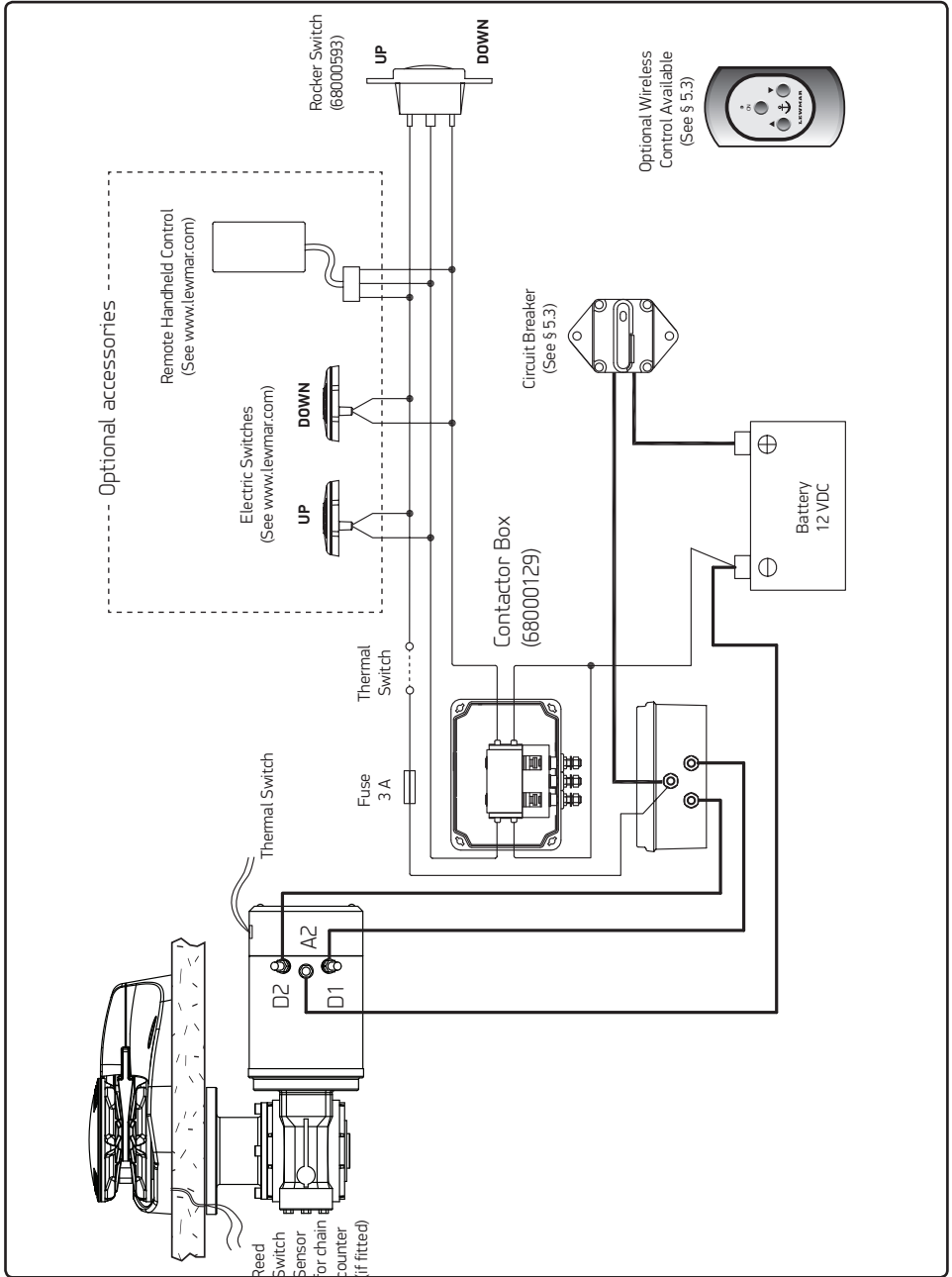

## 6- Operation

### 6.1 Manual controlled freefall

Use this method for quicker anchor deployment, in an emergency involving loss of power or to save battery power. Observe maritime anchor deployment safety rules.

**⚠ WARNING!** Isolate (Turn off) the windlass using circuit breaker / isolator.

**⚠ WARNING!** Trapping, crushing or entanglement danger whilst operating windlass manually or under power

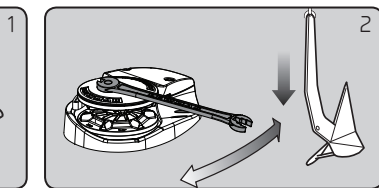
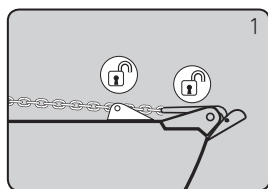

**⚠ WARNING!** Always remove wrench handle after use

1. Release any anchor locks
2. Insert the Lewmar lever in to the gypsy drive cap. When safe, rotate handle anti-clockwise until

anchor pays out, controlling the rate of descent of the anchor with the handle. Once paid out fully tighten gypsy drive cap and remove handle.

### 6.2 Power up/down

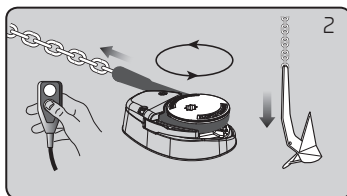
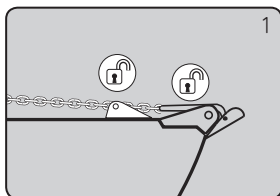

#### To release anchor:

1. Release any anchor locks.
2. Engage the circuit breaker/isolator. When safe, operate DOWN control.

#### To retrieve anchor:

Retrieving the anchor is the reverse to the above.

- When safe, operate the UP control.
- Once anchor is retrieved, ensure it is adequately secured to an independent strong point.

## 6.3 Windlass operating procedures

This is an anchor recovery device. DO NOT use the windlass to pull the boat to the anchor as it will damage the mechanism. Vessels at anchor will snub on the rode and this can cause slippage or apply excessive loads to the windlass. Best practice is to use a bollard or other strong point when at anchor and use the vessels engines to break the anchor free. Otherwise excessive load will cause the freefall function to seize and can cause damage to the gearbox.

⊘ When retrieving anchor do not overload or stall in windlass.

⊘ The rode should be secured directly to a bollard, sampson post or cleat and a chain secured by a chain stopper.

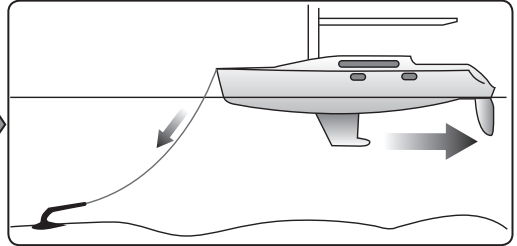
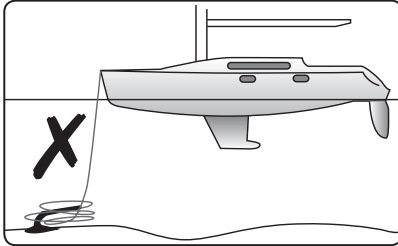

When anchoring, power rode out allowing the vessel to take up stern away preventing the rode tangling with anchor. Use this method for mooring stern first to a jetty.

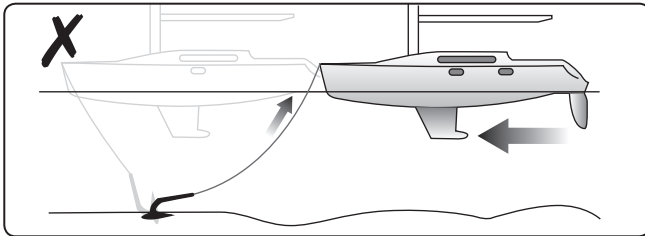

To aid recovery, under power, move vessel towards anchor but not over and beyond, as this can cause damage to topside.

As anchor approaches the vessel use careful adjustments of controls to avoid damaging vessel, start and stop the windlass to bring the anchor slowly into the bow roller.

Pulling the last bit of rode and anchor into the bow roller at full speed can damage the boat, bow roller and windlass.

When stowing it is important to make sure, particularly with rode lines that there is at least 300mm (12") of free space below the windlass (See §4.5). Stop and check during the stowing process to determine if there is sufficient space on you vessel. If the rode pile is too close to the underside of the windlass, re-distribute the rode away from directly below the windlass. If the rode gets too close to the underside of the windlass it will cause problems with good rode recovery and may cause damage to the line.

## 7- Servicing

**⚠ WARNING!** Isolate the windlass using circuit breaker/isolator

**⚠ WARNING!** Ensure rode is adequately secured to an independent strong point

### 7.1 Servicing schedule

The service period is determined by the frequency of use. Professional user will need to carry out these operations more often than the weekend user. Before commencing any work on this or any other electrical product, isolate from the power source.

Bedding in period:

When new there are some areas that will need frequent checking. If no movement is found they can be inspected less often.

- Examine all electrical connections, to make sure they are sound and corrosion hasn't set in. Tighten if necessary and protect if required.
- Check mounting studs are firmly clamped and tighten if required.

After use:

- Wash down the windlass using fresh water.
- Check anchor locker drain
- Ensure rode is at least 12" (300mm) below the windlass
- Check rode and splice for wear.
- Check motor is dry and free of rust

Annually or more often if frequent user:

- Examine all electrical connections, to make sure they are sound and corrosion hasn't set in. Tighten if necessary and protect if required.
- Check motor/gearbox for corrosion, clean and repaint with a suitable marine grade oil based enamel paint.
- Check mounting studs are firmly clamped and tighten if required.
- Remove electric motor cover and blow dust away from brushes using foot pump or similar taking care not to breathe any dust.
- Check rode and splice for wear.
- Check gypsy as it is a high wear item (For service and replacement see §7.2)

### 7.2 Gypsy replacement/service

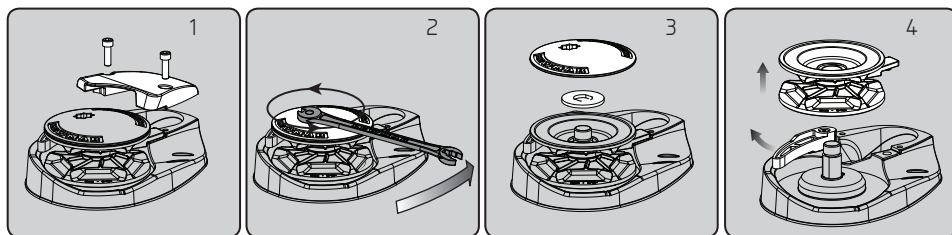

1. Remove chain pipe cover screws using 5 mm Allen key.
2. Place lever into gypsy drive cap, rotate anti-clockwise and remove.
3. Remove drive washer.
4. Pull control arm back to clear gypsy and remove gypsy assembly. Wash with clean water - DO NOT JET WASH.
5. Assemble in reverse order. When reassembling the drive washer and gypsy, add a small smear of grease to the contact surfaces. Lightly grease thread at top of mainshaft, and chain pipe cover screws'

---

## 7.3 Control arm replacement/ service

---

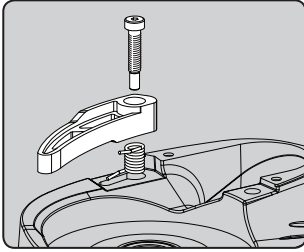

Remove gypsy, proceed as §7.2.

- Unscrew control arm shoulder screw using a 3 mm Allen key.
- Remove control arm and torsion spring from the base plate.
- Wash with clean water (Not Jetwash). Replace components if necessary. Assemble in reverse order and apply grease to spring

## 8- Troubleshooting

### 1. Anchor rode pays out independently while windlass is not in use.

- This problem is a result of not securing the anchor rode combined with the gypsy drive cap being slack. Tighten the gypsy drive cap using the winch handle and always secure the anchor rode independently of the windlass when not in use.

### 2. Failure to operate or sluggish operation.

- The majority of these problems are electrical in nature. It is essential that the proper voltage be maintained. The typical operating voltage range at the motor is 10.5 - 14 Volts, constant low voltage will damage motor.

Ensure electrical cable size is large enough to handle the current draw and keep voltage drop within acceptable limits.

- Check control switches, connections, battery condition, isolator switch, fuse and motor for operation failure.

### 3. Failure to operate.

- Is there a voltage at the input terminals to the contactor and switches. Check the circuit breaker/isolator switch and any fuses.
- Operate the switch. Is there voltage at the positive switch terminal on the solenoid. If not, the switch (or its wiring), is defective.
- Keep the switch activated. Is there voltage at the main output terminal on the contactor. If not check the contactor coil ground circuit. If okay, replace the contactor.
- Check the voltage at the motor. If voltage of at least 9 volts is present and the motor does not operate, the motor may be defective.

## 9- Part List

KIT NO	DESCRIPTION	ITEMS INCLUDED (QTY)
66000770	Base kit	6(1), 12(1), 22(1), 25(2)
66000771	Chain cover kit	13(1), 21(2)
66000601	Gypsy cap kit	2(1), 16(1)
66000772	Cone and washer kit	2(1), 8(1), 10(1)
66000600	Control arm kit	1(1), 3(1), 15(1)
66000773	Mounting kit	7(1), 14(1)
66000774	Driveshaft kit	4(1), 9(1), 11(1), 23(1), 24(1)
68001123	8mm - 5/16" Gypsy and stripper kit	18(1)
68001126	6mm - 7mm - 1/4" Gypsy and stripper kit	20(1)
68001125	12V, 500W MGB and contactor	19(1)
68001035	12V, 700W MGB and contactor	17(1)
65001206	Clutch lever	26 (1)

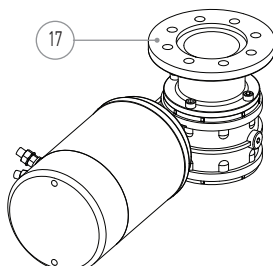
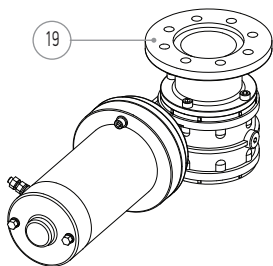



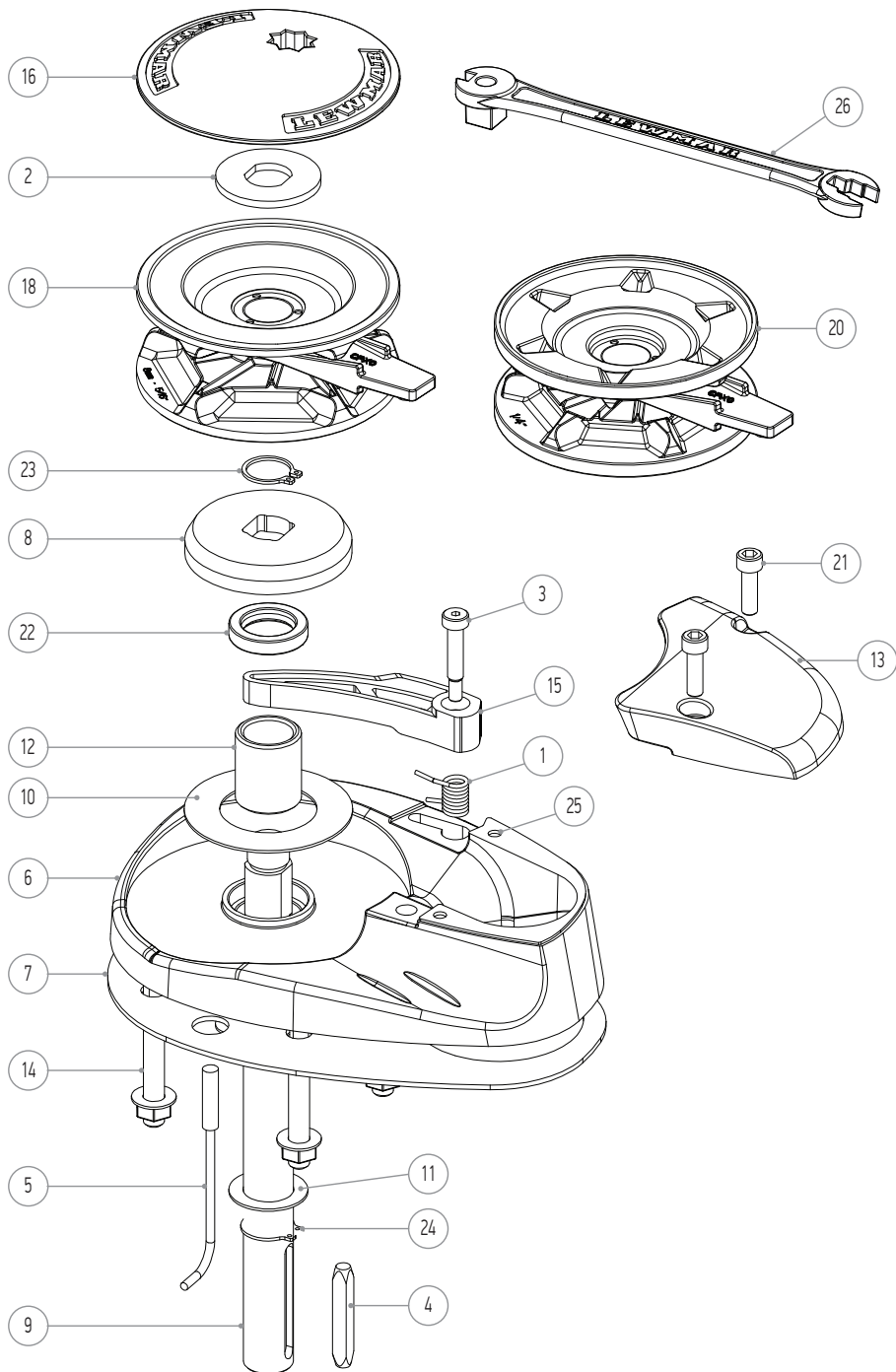

## 9- Warranty

### Limited Warranty and Key Terms of Supply by Lewmar

Lewmar warrants that in normal private pleasure boat usage and with proper maintenance its products will conform with their specification for a period of three years from the date of purchase by the end user, subject to the conditions, limitations and exceptions listed below. Any product, which proves to be defective in normal usage during that three-year period, will be repaired or, at Lewmar's option, replaced by Lewmar.

#### A CONDITIONS AND LIMITATIONS

- i Lewmar's liability shall be limited to the repair or replacement of any parts of the product which are defective in materials or workmanship.
- ii Responsibility for the selection of products appropriate for the use intended by the Buyer shall rest solely with the Buyer and Lewmar accepts no responsibility for any such selection.
- iii Lewmar shall not be liable in any way for Product failure, or any resulting loss or damage that arises from:
  - a. use of a product in an application for which it was not designed or intended;
  - b. corrosion, ultra violet degradation or wear and tear;
  - c. a failure to service or maintain the product in accordance with Lewmar's recommendations;
  - d. faulty or deficient installation of the product (unless conducted by Lewmar);
  - e. any modification or alteration of the product;
  - f. conditions that exceed the product's performance specifications or safe working loads.
- g. Abuse
- iv Product subject to a warranty claim must be returned to the Lewmar outlet that supplied the product for examination unless otherwise approved by Lewmar in writing.
- v This warranty does not cover any incidental costs incurred for the investigation, removal, carriage, transport or installation of product.
- vi Service by anyone other than authorized Lewmar representatives shall void this warranty unless it accords with Lewmar guidelines and standards of workmanship.
- vii Lewmar's products are intended for use only in the marine environment. Buyers intending to use them for any other purpose should seek independent professional advice as to their suitability. Lewmar accepts no liability arising from such other use.

#### B EXCEPTIONS

Cover under this Warranty is limited to a period of one year from the date of purchase by the end user in the case of any of the following products or parts of products:

- Electric motors and associated electrical equipment
- Electronic controls
- Hydraulic pumps, valves and actuators
- Hatch & Portlight weather seals
- Products used in "Grand Prix" racing applications
- Products used in commercial or charter applications
- Anchor rodes

#### C LIABILITY

- i Lewmar's liability under this warranty shall be to the exclusion of all other warranties or liabilities (to the extent permitted by law). In particular (but without limitation):

a. Lewmar shall not be liable for:

- Any loss of anticipated turnover or profit or indirect, consequential or economic loss;
- Damages, costs or expenses payable to any third party;
- Any damage to yachts or equipment;
- Death or personal injury (unless caused by Lewmar's negligence).

Some states and countries do not allow the exclusion or limitation of incidental or consequential damages, so the above limitation or exclusion may not apply to you

b. Lewmar grants no other warranties regarding the fitness for purpose, use, nature or satisfactory quality of the products.

- ii Where applicable law does not permit a statutory or implied warranty to be excluded, then such warranty, if permitted by that state or country's law, shall be limited to a period of one year from the date of purchase by the end user. Some states and countries do not allow limitations on how long an implied warranty lasts, so this limitation may not apply to you.

#### D PROCEDURE

Notice of a claim for service under this warranty shall be made promptly and in writing by the end user to the Lewmar outlet that supplied the product or to Lewmar Limited at Southmoor Lane, Havant, Hampshire PO9 1JJ, England.

#### E SEVERANCE CLAUSE

If any clause of this warranty is held by any court or other competent authority to be invalid or unenforceable in whole or in part, the validity of the remaining clauses of this warranty and the remainder of the clause in question shall not be affected.

#### F OTHER RIGHTS

This warranty gives you specific legal rights, and you may also have other legal rights, which vary from state to state and country to country.

In the case of European States a Consumer customer (as defined nationally) has legal rights under the applicable national law governing the sale of Consumer Goods; this Warranty does not affect those rights.

#### G LAW

This warranty shall be governed by and read in accordance with the laws of England or the state or country in which the first end user is domiciled at the time of purchase of the product.

#### H DISPUTES

Any dispute arising under this warranty may, at the option of the end-user, be referred to alternative dispute resolution under the rules of the British Marine Federation or to the Courts of the State whose law shall govern the warranty or to the Courts of England and Wales.

The British Marine Federation may be contacted at Marine House, Thorpe Lea Road, Egham, England, TW20 8BF



## UK & International Distribution

Lewmar / Navtec  
Southmoor Lane  
Havant  
Hampshire  
PO9 1JJ  
England

**Tel:** +44 (0)23 9247 1841

**Fax:** +44 (0)23 9248 5720

**Email:** [info@lewmar.com](mailto:info@lewmar.com)

## USA

Lewmar / Navtec  
351 New Whitfield Street  
Guilford, CT  
06437  
USA

**Tel:** +1 203 458 6200

**Fax:** +1 203 453 5669

**Email:** [info@lewmarusa.com](mailto:info@lewmarusa.com)

# LEWMAR®

[www.lewmar.com](http://www.lewmar.com)

Part No B 10408 iss.1